

Cell Specification Data

SLPB 523452



Kokam Co., Ltd.

Cell Specification

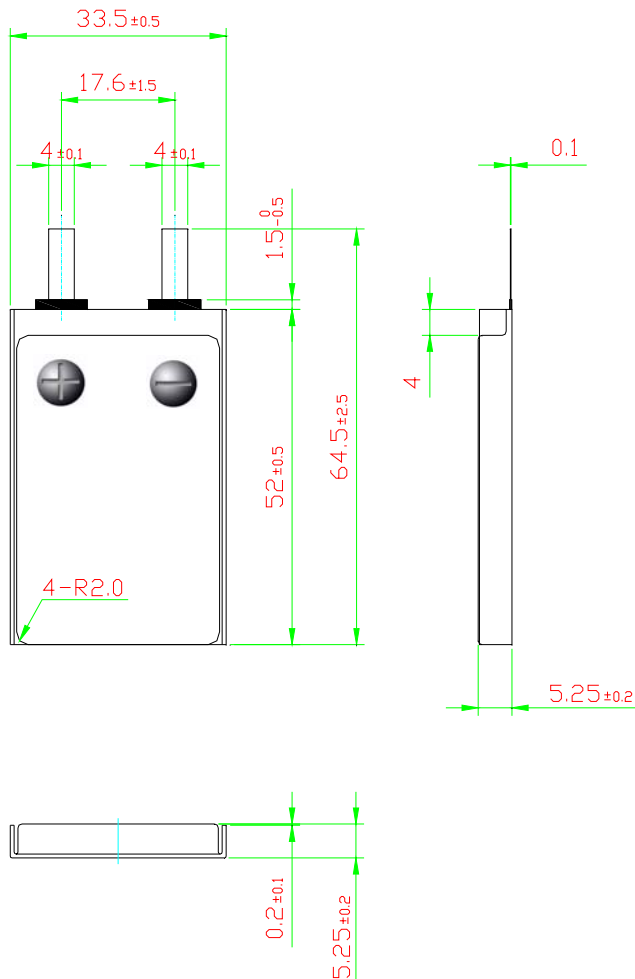

● Typical Capacity ¹⁾		880 mAh
● Nominal Voltage		3.7 V
● Charge Condition	Max. Current	880 mA
	Voltage	$4.2V \pm 0.03 V$
● Discharge Condition	Continuous Current	1.76 A
	Peak Current	4.4 A
	Cut-off Voltage	2.7 V
● Cycle Life		> 500 Cycles
● Operating Temp.	Charge	0 ~ 40 °C
	Discharge	-20 ~ 60 °C
● Dimension	Thickness (mm)	5.25 ± 0.2
	Width (mm)	33.5 ± 0.5
	Length (mm)	52.0 ± 0.5
● Weight (g)		18.0 ± 2.0

1) Typical Capacity : 0.5C, 4.2~2.7V @25°C,